



**2 PORT SLIP - IN
CARTRIDGE VALVES (ISO 7368)
Model : CV*****

Ref. No. D 03426
Release 01 / 2018

ENGINEERING - 1 of 13

A Polyhydron Group Company

Description

The cartridge valves with model CV*** are used to control oil pressure flow rate or direction and are designed for insertion into cavities machined as per ISO 7368. These cartridges are available in two area ratios, four cracking pressures and seven poppet styles. The covers are available for different functions like directional control, pressure control, unloading, flow control etc.



Section

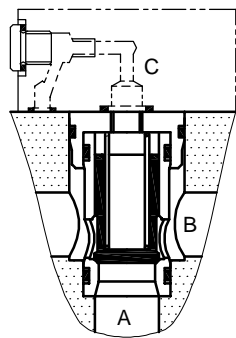

CV*P*O -*

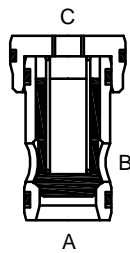

CV*P*C -*

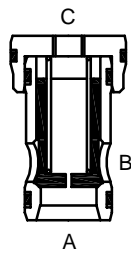

CV*R*O -*

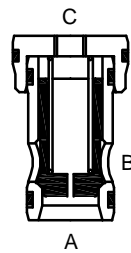

CV*R*C -*

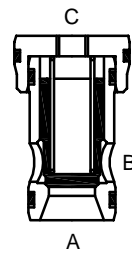

CV*K*O -*

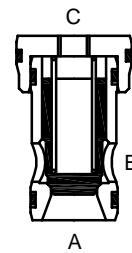

CV*K*C -*

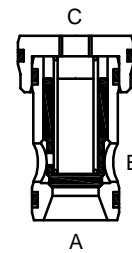

CV*C*O -*

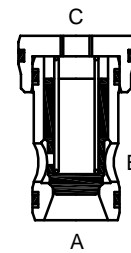

CV*C*C -*

Models

AA = Area of poppet exposed to port 'A'.
CA = Area of poppet exposed to control pressure.
AA : CA = Area Ratio.

Hydraulic symbols

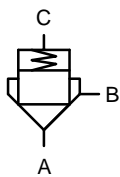

Standard cartridge
Area ratio
(1:1)

CV*P*O -*

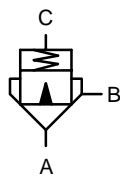

Cartridge with
Cushion nose
Area ratio
(1:1)

CV*P*C -*

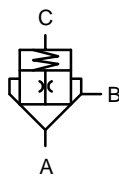

Relief cartridge
with orifice
Area ratio
(1:1)

CV*R*O -*

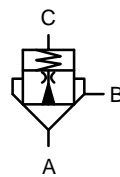

Relief cartridge
with orifice and
cushion nose
Area ratio
(1:1)

CV*R*C -*

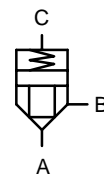

Standard cartridge
Area ratio
(1:1.5)

CV*K*O -*

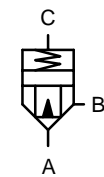

Cartridge with
Cushion nose
Area ratio
(1:1.5)

CV*K*C -*

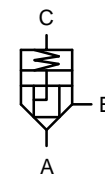

Check cartridge
Area ratio
(1:1.5)

CV*C*O -*

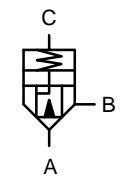

Check cartridge
with Cushion nose
Area ratio
(1:1.5)

CV*C*C -*



Unit dimensions

Dimensions in mm.

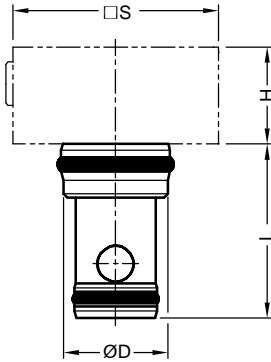
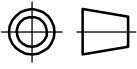
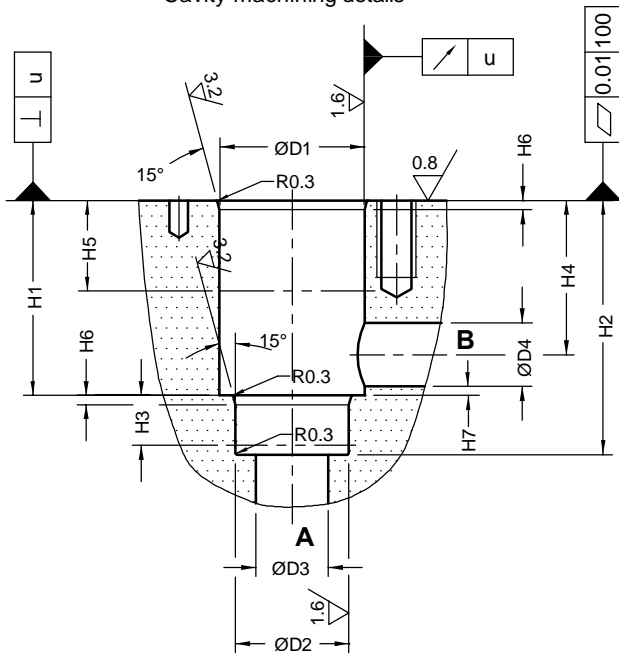

Table no. 1

Size	16	25	32	40
H	Refer individual cover			
L-0.1	56	72	85	105
ØD	32	45	60	75
□S	Refer individual cover			

Cavity machining details



Cover mounting interface as per ISO 7368.

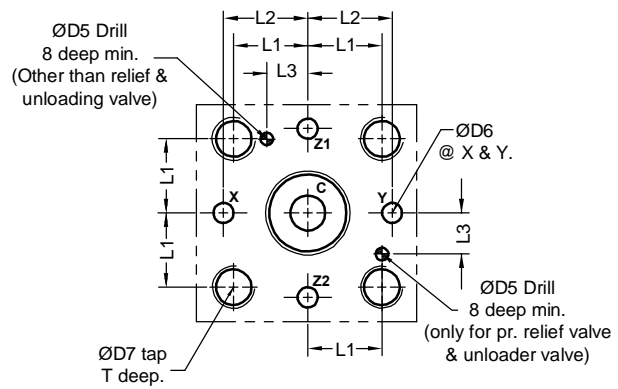

Table no. 2

Size	L1 ±0.2	L2 ±0.2	L3 ±0.2	ØD1 H8	ØD2 H8	ØD3 max	ØD4		ØD5 H13	ØD6 max	ØD7	T	Tightening Torque.	H1 +0.1	H2 ±0.1	H3*	H4		H5*	H6	H7 min	u
							min	max									min	max				
16	23	25	10.5	32	25	16	16	25	4	4	M8	14	39 Nm	43	56	11	29.5	34	20	2	0.5	0.03
25	29	33	16	45	34	25	25	32	6	6	M12	20	135 Nm	58	72	12	40.5	44	30	2.5	1	0.03
32	35	41	17	60	45	32	32	40	6	8	M16	26	330 Nm	70	85	13	48	52	30	2.5	1.5	0.03
40	42.5	50	23	75	55	40	40	50	6	10	M20	33	650 Nm	87	105	15	59	64	30	3	2.5	0.05

* Depth of finish.



Technical specifications

Construction Seat type.

Mounting type Insert in cavity conforming to ISO 7368 , DIN 24342 .

Mounting position Optional.

Flow direction Model with (1:1) -- CV*P*O -*
 CV*P*C -* **A → B**
 CV*R*O -*
 CV*R*C -*

Model with (1:1.5) -- CV*K*O -*
 CV*K*C -* **A ↔ B**
 CV*C*O -*
 CV*C*C -*

Area ratio (A_A:C_A)..... (1:1) for Model : CV*P*O -*, CV*P*C -*, CV*R*O -*, CV*R*C -*
 (1:1.5) for Model : CV*K*O -*, CV*K*C -*, CV*C*O -*, CV*C*C -*

Operating pressure at port A, B, X, Z1, Z2 350 bar.
 (For Y port refer individual cartridge cover catalogue)

Cracking pressure

Spring type	Area ratio		
	1 : 1	1 : 1.5	
	Flow direction		
	A to B	A to B	B to A
Cracking pressure (bar)			
X	0.0	0.0	0.0
A	0.3	0.45	0.0
B	0.6	0.9	1.8
C	1.2	1.8	3.6
D	2.3	3.5	7.1

Hydraulic medium Mineral oil.

Viscosity range 10 to 380 cSt.

Fluid temperature range -10 °C to +70 °C.

Fluid cleanliness requirement ISO 4406 20/18/15 or better.

Flow handling capacity (l/min) Refer graphs.

Pilot volume (cm³) Valve size : 16 25 32 40
 Volume : 1.6 3.8 8.0 16.6



Performance curve

Oil Used : VG 68, Viscosity : 68 cSt @ 40 °C, Temperature @ test : 50 °C.

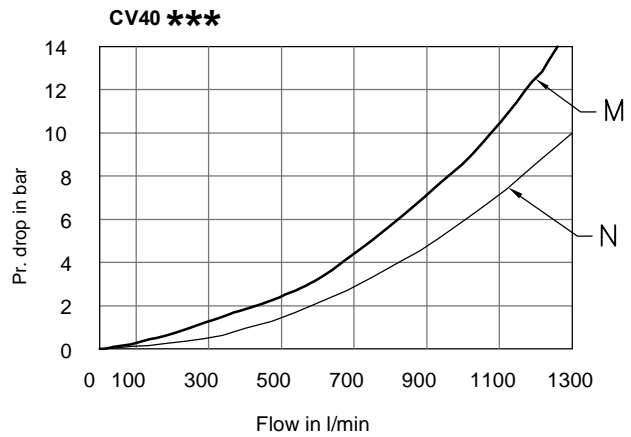
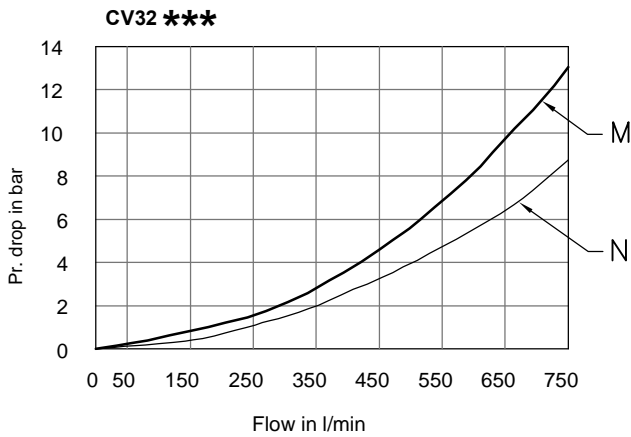
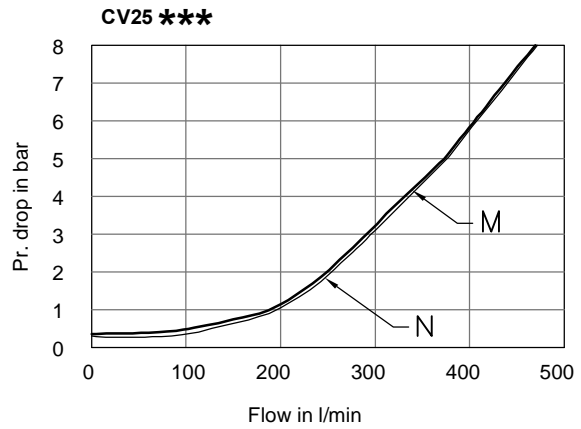
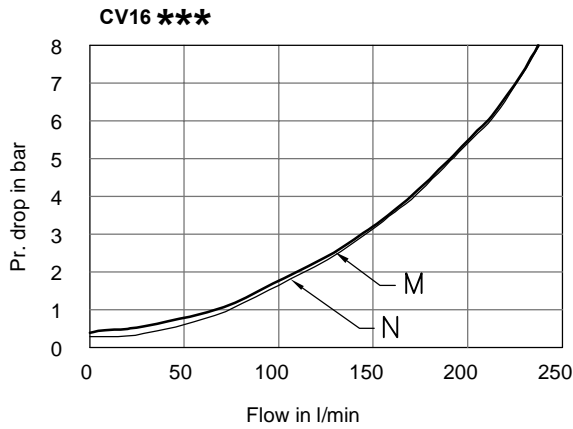

M - With cushioning shoulder ———
N - Without cushioning shoulder ———

Note : The indicated characteristics curves have been determined without inserting springs and show average values with regard to flow from A to B or B to A for 1:1 and 1:1.5 area ratio cartridges.

Ordering code

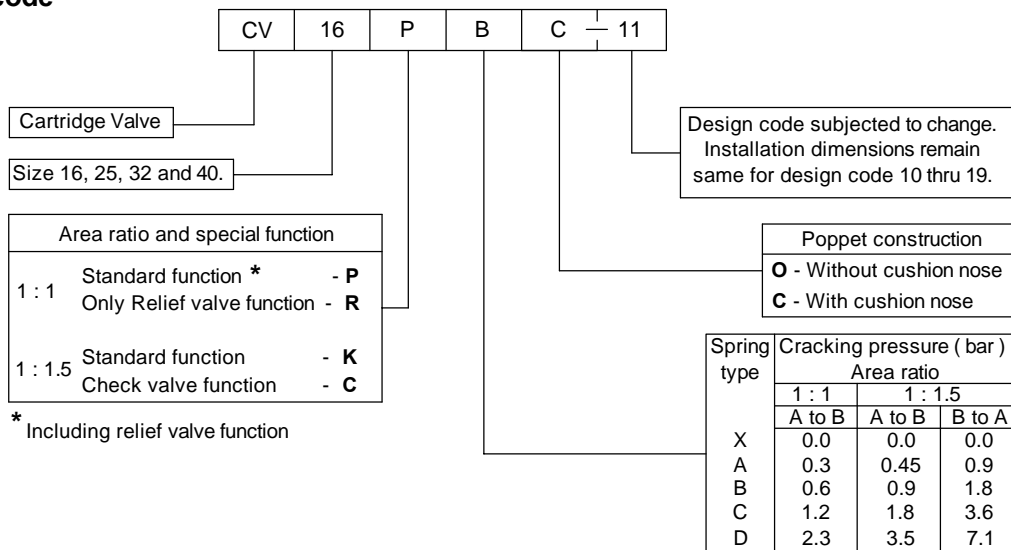



Types of cartridge covers available

Symbolic function	Size 16	Size 25	Size 32	Size 40
	Standard cover			
	Brief code and datasheet no.			
	CVC16XP* D 03417	CVC25XP* D 03417	CVC32XP* D 03417	CVC40XP* D 03417
	Relief cover			
	Brief code and datasheet no.			
	CVC16R*** D 03418	CVC25R*** D 03418	CVC32R*** D 03418	CVC40R*** D 03418
	Relief cover with provision of solenoid unloading normally closed			
	Brief code and datasheet no.			
	CVC16R**A* D 03418	CVC25R**A* D 03418	CVC32R**A* D 03418	CVC40R**A* D 03418
	Relief cover with provision of solenoid unloading normally open			
	Brief code and datasheet no.			
	CVC16R**B* D 03418	CVC25R**B* D 03418	CVC32R**B* D 03418	CVC40R**B* D 03418
	Relief cum unloader, unloading by pilot pressure			
	Brief code and datasheet no.			
	CVC16U*** D 03419	CVC25U*** D 03419	CVC32U*** D 03419	CVC40U*** D 03419

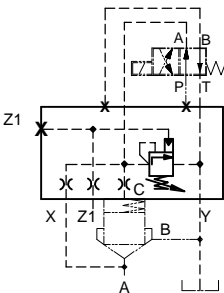
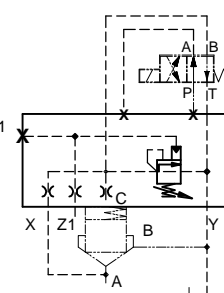
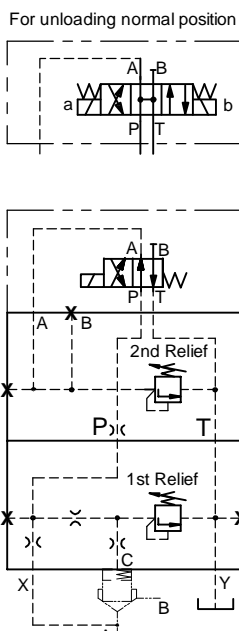

Symbolic function	Size 16	Size 25	Size 32	Size 40
	Relief cum unloader, unloading by pilot pressure with provision for solenoid unloading normally closed			
	Brief code and datasheet no.			
	CVC16U**A*	CVC25U**A*	CVC32U**A*	CVC40U**A*
	D 03419	D 03419	D 03419	D 03419
	Relief cum unloader, unloading by pilot pressure with provision for solenoid unloading normally open			
	Brief code and datasheet no.			
	CVC16U**B*	CVC25U**B*	CVC32U**B*	CVC40U**B*
	D 03419	D 03419	D 03419	D 03419
<p>For unloading normal position</p>  <p style="text-align: center;">CVC*2RSA***</p>	Cover for 2 manual pressure setting, electrically selectable with 2nd relief valve on A			
	Brief code and datasheet no.			
	CVC16-2RSA***	CVC25-2RSA***	CVC32-2RSA***	CVC40-2RSA***
	D 07032	D 07032	D 07032	D 07032

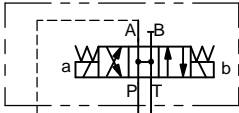
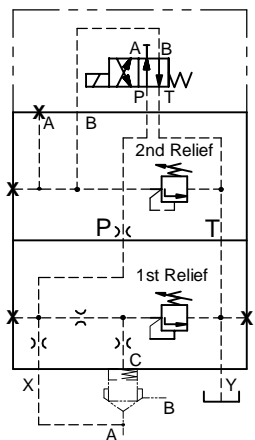
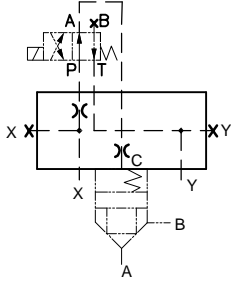
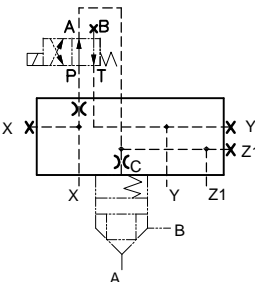

Cartridge cover details

Symbolic function	Size 16	Size 25	Size 32	Size 40
<p>For unloading normal position</p>  	<p>Cover for 2 manual pressure setting, electrically selectable with 2nd relief valve on B</p>			
Brief code and datasheet no.				
CVC16-2RSB***	CVC25-2RSB***	CVC32-2RSB***	CVC40-2RSB***	
D 07032	D 07032	D 07032	D 07032	
	<p>Cover with provision for spool type D.C.V solenoid operated control port normally connected to A</p>			
Brief code and datasheet no.				
CVC16DEA*	CVC25DEA*	CVC32DEA*	CVC40DEA*	
D 03428	D 03428	D 03428	D 03428	
	<p>Cover with provision for spool type D.C.V solenoid operated control port normally connected to A, with parallel connection available at Z1</p>			
Brief code and datasheet no.				
CVC16DEA-AZ1*	CVC25DEA-AZ1*	CVC32DEA-AZ1*	CVC40DEA-AZ1*	
D 03428	D 03428	D 03428	D 03428	



Symbolic function	Size 16	Size 25	Size 32	Size 40
	Cover with provision for spool type D.C.V solenoid operated control port normally connected to B			
	Brief code and datasheet no.			
	CVC16DEB* D 03428	CVC25DEB* D 03428	CVC32DEB* D 03428	CVC40DEB* D 03428
	Cover with provision for spool type D.C.V solenoid operated control port normally connected to B, with parallel connection available at Z2			
	Brief code and datasheet no.			
	CVC16DEB-BZ2* D 03428	CVC25DEB-BZ2* D 03428	CVC32DEB-BZ2* D 03428	CVC40DEB-BZ2* D 03428
	Cover with provision for spool type D.C.V solenoid operated control port normally connected to A and B is available at Z2			
	Brief code and datasheet no.			
	CVC16DEA-BZ2* D 03428	CVC25DEA-BZ2* D 03428	CVC32DEA-BZ2* D 03428	CVC40DEA-BZ2* D 03428
	Cover with provision for spool type D.C.V solenoid operated control port normally connected to A, with parallel connection available at Z1 and B is available at Z2			
	Brief code and datasheet no.			
	CVC16DEA-AZ1-BZ2* D 03428	CVC25DEA-AZ1-BZ2* D 03428	CVC32DEA-AZ1-BZ2* D 03428	CVC40DEA-AZ1-BZ2* D 03428



Symbolic function	Size 16	Size 25	Size 32	Size 40								
<p>Diagram showing a 3-position solenoid valve with ports A, B, C, X, Y, Z1, Xx, Yy, Zz. A solenoid is connected to ports B and A. Port A is available at Z1.</p>	<p>Cover with provision for spool type D.C.V solenoid operated control port normally connected to B and A is available at Z1</p> <p style="text-align: center;">Brief code and datasheet no.</p> <table border="1"> <tr> <td>CVC16DEB-AZ1*</td> <td>CVC25DEB-AZ1*</td> <td>CVC32DEB-AZ1*</td> <td>CVC40DEB-AZ1*</td> </tr> <tr> <td>D 03428</td> <td>D 03428</td> <td>D 03428</td> <td>D 03428</td> </tr> </table>				CVC16DEB-AZ1*	CVC25DEB-AZ1*	CVC32DEB-AZ1*	CVC40DEB-AZ1*	D 03428	D 03428	D 03428	D 03428
CVC16DEB-AZ1*	CVC25DEB-AZ1*	CVC32DEB-AZ1*	CVC40DEB-AZ1*									
D 03428	D 03428	D 03428	D 03428									
<p>Diagram showing a 3-position solenoid valve with ports A, B, C, X, Y, Z1, Xx, Yy, Zz. A solenoid is connected to ports B and C. Port A is available at Z1, and port C is available at Z2.</p>	<p>Cover with provision for spool type D.C.V solenoid operated control port normally connected to B, with parallel connection available at Z2 and A is available at Z1</p> <p style="text-align: center;">Brief code and datasheet no.</p> <table border="1"> <tr> <td>CVC16DEB-AZ1-BZ2*</td> <td>CVC25DEB-AZ1-BZ2*</td> <td>CVC32DEB-AZ1-BZ2*</td> <td>CVC40DEB-AZ1-BZ2*</td> </tr> <tr> <td>D 03428</td> <td>D 03428</td> <td>D 03428</td> <td>D 03428</td> </tr> </table>				CVC16DEB-AZ1-BZ2*	CVC25DEB-AZ1-BZ2*	CVC32DEB-AZ1-BZ2*	CVC40DEB-AZ1-BZ2*	D 03428	D 03428	D 03428	D 03428
CVC16DEB-AZ1-BZ2*	CVC25DEB-AZ1-BZ2*	CVC32DEB-AZ1-BZ2*	CVC40DEB-AZ1-BZ2*									
D 03428	D 03428	D 03428	D 03428									
<p>Diagram showing a shuttle valve with ports X, Y, Z1, Z2, C, B, A. A shuttle valve is built into the cover.</p>	<p>Cover with built in Shuttle valve</p> <p style="text-align: center;">Brief code and datasheet no.</p> <table border="1"> <tr> <td>CVC16S*</td> <td>CVC25S*</td> <td>CVC32S*</td> <td>CVC40S*</td> </tr> <tr> <td>D 03424</td> <td>D 03424</td> <td>D 03424</td> <td>D 03424</td> </tr> </table>				CVC16S*	CVC25S*	CVC32S*	CVC40S*	D 03424	D 03424	D 03424	D 03424
CVC16S*	CVC25S*	CVC32S*	CVC40S*									
D 03424	D 03424	D 03424	D 03424									
<p>Diagram showing a shuttle valve with a solenoid and directional spool valve. Ports include X, Y, Z1, Z2, C, B, A. The solenoid is connected to port A.</p>	<p>Cover with built in Shuttle valve with provision for fitting a directional spool valve, control port normally connected to port A</p> <p style="text-align: center;">Brief code and datasheet no.</p> <table border="1"> <tr> <td>CVC16SDEA*</td> <td>CVC25SDEA*</td> <td>CVC32SDEA*</td> <td>CVC40SDEA*</td> </tr> <tr> <td>D 03477</td> <td>D 03477</td> <td>D 03477</td> <td>D 03477</td> </tr> </table>				CVC16SDEA*	CVC25SDEA*	CVC32SDEA*	CVC40SDEA*	D 03477	D 03477	D 03477	D 03477
CVC16SDEA*	CVC25SDEA*	CVC32SDEA*	CVC40SDEA*									
D 03477	D 03477	D 03477	D 03477									



Symbolic function	Size 16	Size 25	Size 32	Size 40								
<p>A</p>	<p>Cover with built in Shuttle valve with provision for fitting a directional spool valve, control port normally connected to port B</p> <p>Brief code and datasheet no.</p> <table border="1"> <tr> <td>CVC16SDEB*</td> <td>CVC25SDEB*</td> <td>CVC32SDEB*</td> <td>CVC40SDEB*</td> </tr> <tr> <td>D 03477</td> <td>D 03477</td> <td>D 03477</td> <td>D 03477</td> </tr> </table>				CVC16SDEB*	CVC25SDEB*	CVC32SDEB*	CVC40SDEB*	D 03477	D 03477	D 03477	D 03477
CVC16SDEB*	CVC25SDEB*	CVC32SDEB*	CVC40SDEB*									
D 03477	D 03477	D 03477	D 03477									
<p>A</p>	<p>Cover with built in Shuttle valve with provision for fitting a directional spool valve, port A of shuttle valve is connected to port A of DCV</p> <p>Brief code and datasheet no.</p> <table border="1"> <tr> <td>CVC16SDEAA*</td> <td>CVC25SDEAA*</td> <td>CVC32SDEAA*</td> <td>CVC40SDEAA*</td> </tr> <tr> <td>D 03495</td> <td>D 03495</td> <td>D 03495</td> <td>D 03495</td> </tr> </table>				CVC16SDEAA*	CVC25SDEAA*	CVC32SDEAA*	CVC40SDEAA*	D 03495	D 03495	D 03495	D 03495
CVC16SDEAA*	CVC25SDEAA*	CVC32SDEAA*	CVC40SDEAA*									
D 03495	D 03495	D 03495	D 03495									
<p>A</p>	<p>Cover with built in Shuttle valve with provision for fitting a directional spool valve, port A of shuttle valve is connected to port B of DCV</p> <p>Brief code and datasheet no.</p> <table border="1"> <tr> <td>CVC16SDEAB*</td> <td>CVC25SDEAB*</td> <td>CVC32SDEAB*</td> <td>CVC40SDEAB*</td> </tr> <tr> <td>D 03495</td> <td>D 03495</td> <td>D 03495</td> <td>D 03495</td> </tr> </table>				CVC16SDEAB*	CVC25SDEAB*	CVC32SDEAB*	CVC40SDEAB*	D 03495	D 03495	D 03495	D 03495
CVC16SDEAB*	CVC25SDEAB*	CVC32SDEAB*	CVC40SDEAB*									
D 03495	D 03495	D 03495	D 03495									
<p>A</p>	<p>Cover with built in pilot operated check valve</p> <p>Brief code and datasheet no.</p> <table border="1"> <tr> <td>CVC16PC*</td> <td>CVC25PC*</td> <td>CVC32PC*</td> <td>CVC40PC*</td> </tr> <tr> <td>D 09809</td> <td>D 09809</td> <td>D 09809</td> <td>D 09809</td> </tr> </table>				CVC16PC*	CVC25PC*	CVC32PC*	CVC40PC*	D 09809	D 09809	D 09809	D 09809
CVC16PC*	CVC25PC*	CVC32PC*	CVC40PC*									
D 09809	D 09809	D 09809	D 09809									



Symbolic function	Size 16	Size 25	Size 32	Size 40
	Cover with stroke limiter			
	Brief code and datasheet no.			
	CVC16TSX* D 03438	CVC16TSX* D 03438	CVC16TSX* D 03438	CVC16TSX* D 03438
	Cover with built in pilot operated check valve and stroke limiter			
	Brief code and datasheet no.			
	CVC16PCT* D 09809	CVC25PCT* D 09809	CVC32PCT* D 09809	CVC40PCT* D 09809
	Cover with stroke limiter, and solenoid provision with control on A			
	Brief code and datasheet no.			
	CVC16TSA* D 62000	CVC25TSA* D 62000	CVC32TSA* D 62000	CVC40TSA* D 62000
	Cover with stroke limiter, and solenoid provision with control on B			
	Brief code and datasheet no.			
	CVC16TSB* D 62000	CVC25TSB* D 62000	CVC32TSB* D 62000	CVC40TSB* D 62000



Symbolic function	Size 16	Size 25	Size 32	Size 40
	Cover with stroke limiter, shuttle valve , and solenoid provision with control on A			
	Brief code and datasheet no.			
	CVC16STSA*	CVC25STSA*	CVC32STSA*	CVC40STSA*
	D 09524	D 09524	D 09524	D 09524
	Cover with stroke limiter, shuttle valve , and solenoid provision with control on B			
	Brief code and datasheet no.			
	CVC16STSB*	CVC25STSB*	CVC32STSB*	CVC40STSB*
	D 09524	D 09524	D 09524	D 09524
	Cover for proportional relief valve			
	Brief code and datasheet no.			
	CVC16PRS**	CVC25PRS**	CVC32PRS**	CVC40PRS**
	D 09636	D 09636	D 09636	D 09636
	Cover with check valve mounting			
	Brief code and datasheet no.			
	----	----	----	----
	----	----	----	----

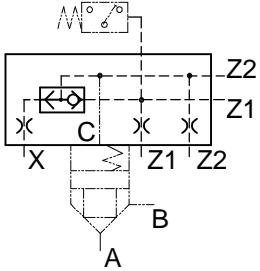

Symbolic function	Size 16	Size 25	Size 32	Size 40
	Cover with built in change over and pressure switch			
Brief code and datasheet no.				

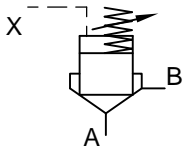
	High cracking pressure cover			
Brief code and datasheet no.				

